

Fig. 1

### A KNOWLEDGE CONTAINER

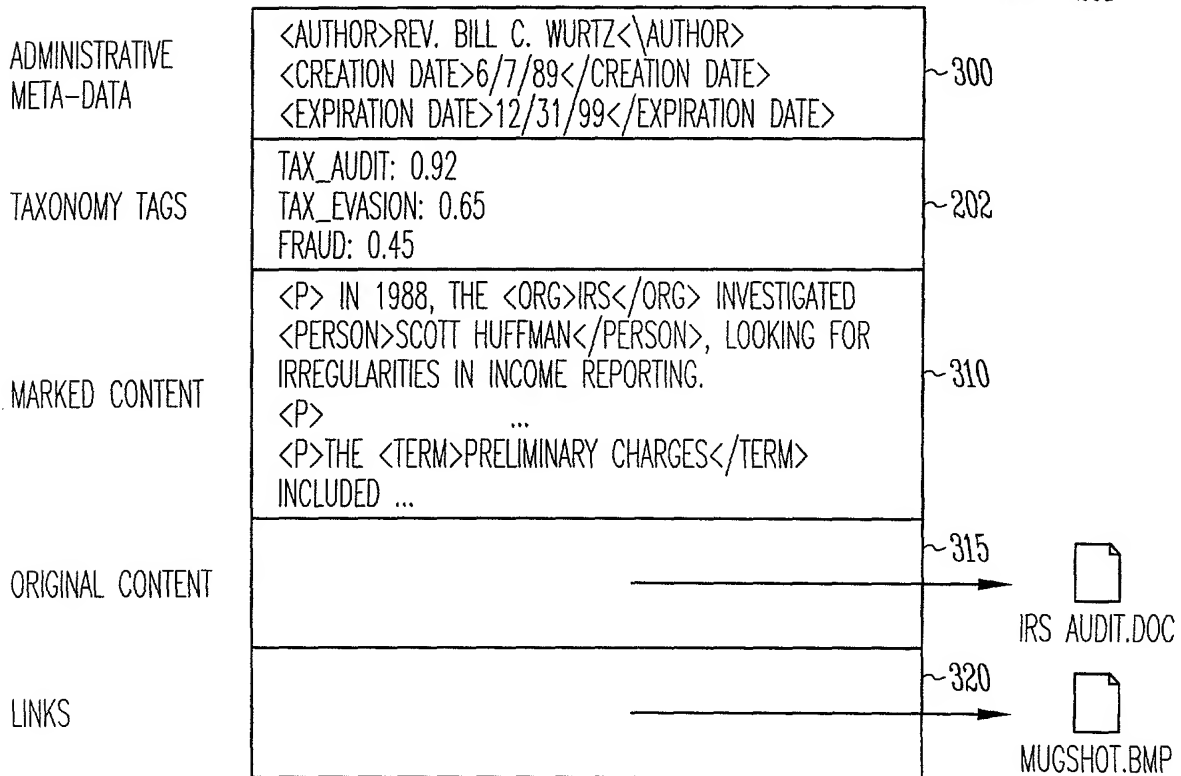

Fig. 3

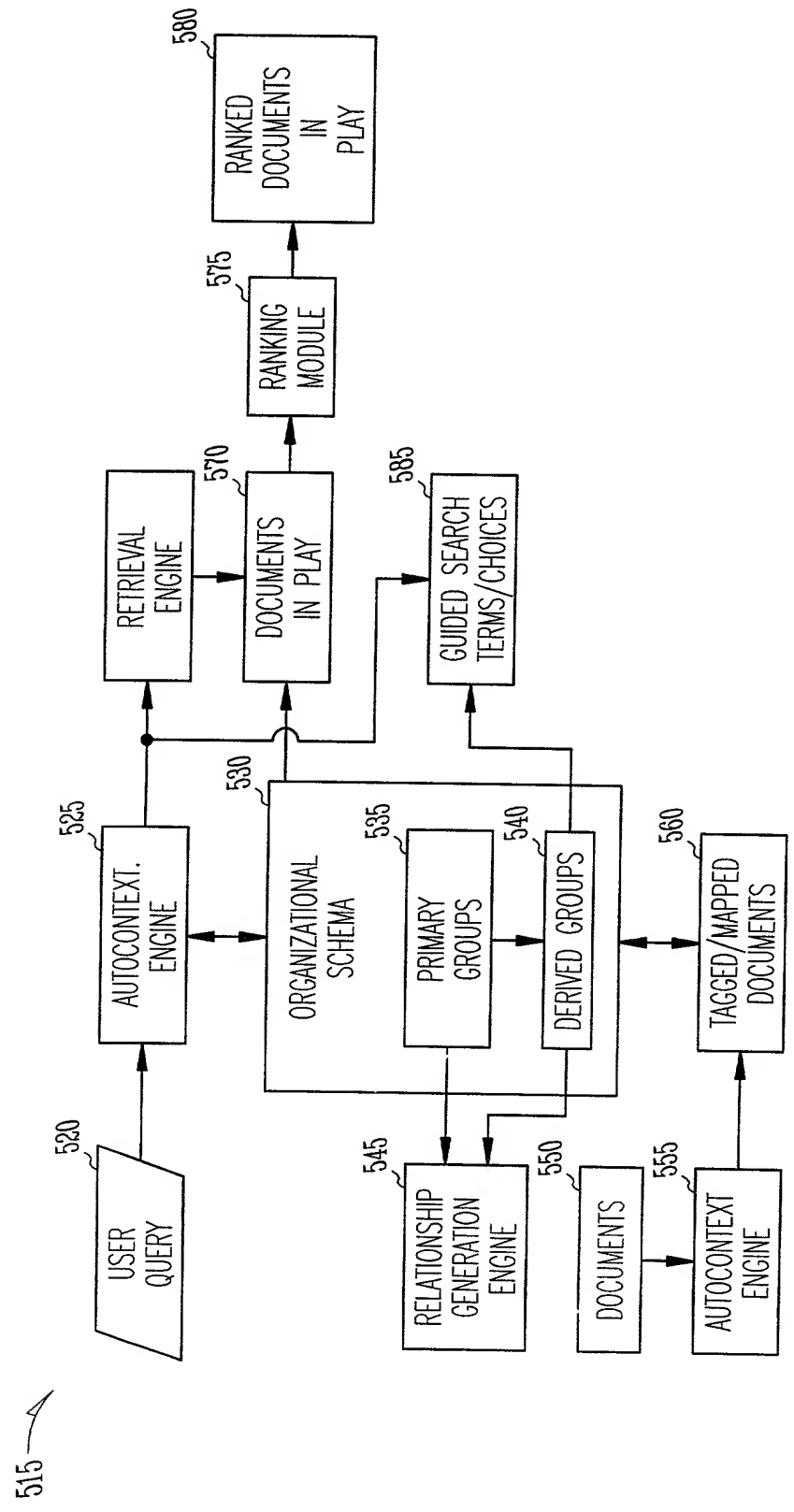

Fig. 5A

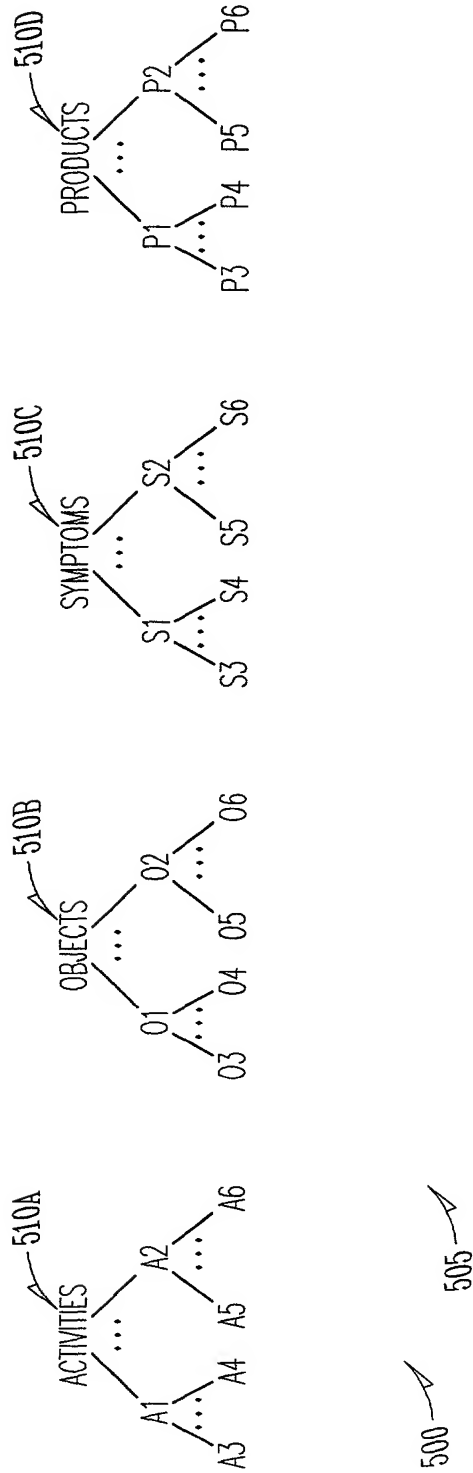

Fig. 5B

$$\begin{bmatrix} A_1 \\ A_2 \\ \vdots \\ A_M \end{bmatrix} = \begin{bmatrix} AO_{11} & AO_{12} & \dots & AO_{1N} \\ AO_{21} & AO_{22} & \dots & AO_{2N} \\ \vdots & \vdots & \dots & \vdots \\ AO_{M1} & \dots & \dots & AO_{MN} \end{bmatrix} \begin{bmatrix} O_1 \\ A_2 \\ \vdots \\ O_N \end{bmatrix}$$

$$\vec{A} = \vec{AO} \vec{O}$$

$$\begin{bmatrix} A_1 \\ A_2 \\ \vdots \\ A_M \end{bmatrix} = \begin{bmatrix} AP_{11} & AP_{12} & \dots & AP_{1N} \\ AP_{21} & AP_{22} & \dots & AP_{2N} \\ \vdots & \vdots & \dots & \vdots \\ AP_{M1} & \dots & \dots & AP_{MN} \end{bmatrix} \begin{bmatrix} P_1 \\ A_2 \\ \vdots \\ P_N \end{bmatrix}$$

$$\vec{A} = \vec{AP} \vec{P}$$

$$\begin{bmatrix} S_1 \\ S_2 \\ \vdots \\ S_M \end{bmatrix} = \begin{bmatrix} SO_{11} & SO_{12} & \dots & SO_{1N} \\ SO_{21} & SO_{22} & \dots & SO_{2N} \\ \vdots & \vdots & \dots & \vdots \\ SO_{M1} & \dots & \dots & SO_{MN} \end{bmatrix} \begin{bmatrix} O_1 \\ O_2 \\ \vdots \\ O_N \end{bmatrix}$$

$$\vec{S} = \vec{SO} \vec{O}$$

$$\begin{bmatrix} S_1 \\ S_2 \\ \vdots \\ S_M \end{bmatrix} = \begin{bmatrix} SP_{11} & SP_{12} & \dots & SP_{1N} \\ SP_{21} & SP_{22} & \dots & SP_{2N} \\ \vdots & \vdots & \dots & \vdots \\ SP_{M1} & \dots & \dots & SP_{MN} \end{bmatrix} \begin{bmatrix} P_1 \\ S_2 \\ \vdots \\ P_N \end{bmatrix}$$

$$\vec{S} = \vec{SP} \vec{P}$$

$$\begin{bmatrix} S_1 \\ S_2 \\ \vdots \\ S_M \end{bmatrix} = \begin{bmatrix} SA_{11} & SA_{12} & \dots & SA_{1N} \\ SA_{21} & SA_{22} & \dots & SA_{2N} \\ \vdots & \vdots & \dots & \vdots \\ SA_{M1} & \dots & \dots & SA_{MN} \end{bmatrix} \begin{bmatrix} A_1 \\ S_2 \\ \vdots \\ A_N \end{bmatrix}$$

$$\vec{S} = \vec{SA} \vec{A}$$

Fig. 6

$$\begin{matrix} \begin{bmatrix} A_1 \\ A_2 \\ \vdots \\ A_M \end{bmatrix} \\ \vec{A} \end{matrix} = \begin{matrix} \begin{bmatrix} AA_{11} & AA_{12} & \dots & AA_{1M} \\ AA_{21} & AA_{22} & \dots & AA_{2M} \\ \vdots & & & \\ AA_{M1} & & \dots & AA_{MM} \end{bmatrix} \\ \vec{AA} \end{matrix} \begin{matrix} \begin{bmatrix} A_1 \\ A_2 \\ \vdots \\ A_M \end{bmatrix} \\ \vec{A} \end{matrix}$$

$$\begin{matrix} \begin{bmatrix} O_1 \\ O_2 \\ \vdots \\ O_N \end{bmatrix} \\ \vec{O} \end{matrix} = \begin{matrix} \begin{bmatrix} OO_{11} & OO_{12} & \dots & OO_{1N} \\ OO_{21} & OO_{22} & \dots & OO_{2N} \\ \vdots & & & \\ OO_{N1} & & \dots & OO_{NN} \end{bmatrix} \\ \vec{OO} \end{matrix} \begin{matrix} \begin{bmatrix} O_1 \\ O_2 \\ \vdots \\ O_N \end{bmatrix} \\ \vec{O} \end{matrix}$$

$$\begin{matrix} \begin{bmatrix} S_1 \\ S_2 \\ \vdots \\ S_M \end{bmatrix} \\ \vec{S} \end{matrix} = \begin{matrix} \begin{bmatrix} SS_{11} & SS_{12} & \dots & SS_{1M} \\ SS_{21} & SS_{22} & \dots & SS_{2M} \\ \vdots & & & \\ SS_{M1} & & \dots & SS_{MM} \end{bmatrix} \\ \vec{SS} \end{matrix} \begin{matrix} \begin{bmatrix} S_1 \\ S_2 \\ \vdots \\ S_M \end{bmatrix} \\ \vec{S} \end{matrix}$$

$$\begin{matrix} \begin{bmatrix} P_0 \\ P_1 \\ \vdots \\ P_N \end{bmatrix} \\ \vec{P} \end{matrix} = \begin{matrix} \begin{bmatrix} P_{11} & P_{12} & \dots & P_{1N} \\ P_{21} & P_{22} & \dots & P_{2N} \\ \vdots & & & \\ P_{N1} & & \dots & P_{NN} \end{bmatrix} \\ \vec{PP} \end{matrix} \begin{matrix} \begin{bmatrix} P_1 \\ P_2 \\ \vdots \\ P_N \end{bmatrix} \\ \vec{P} \end{matrix}$$

Fig. 7

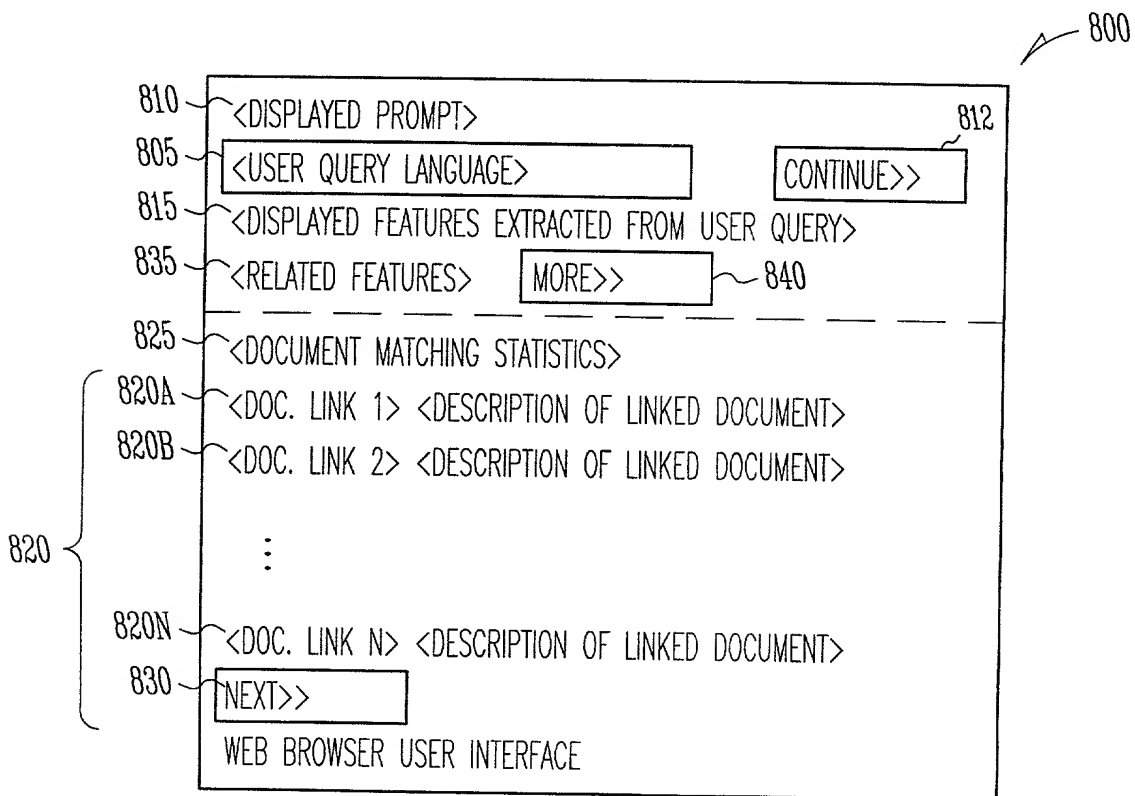

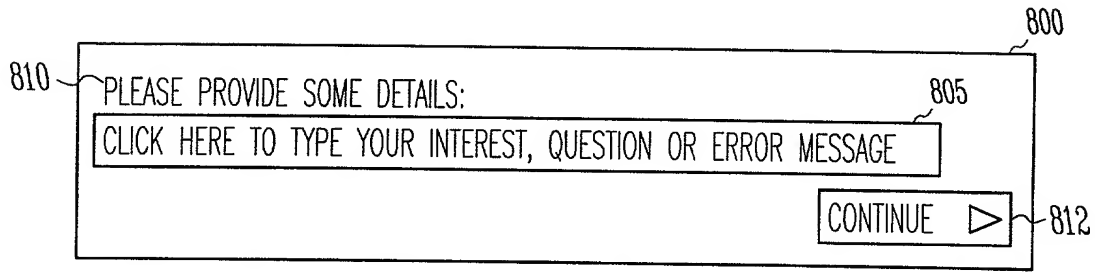

*Fig. 9A*

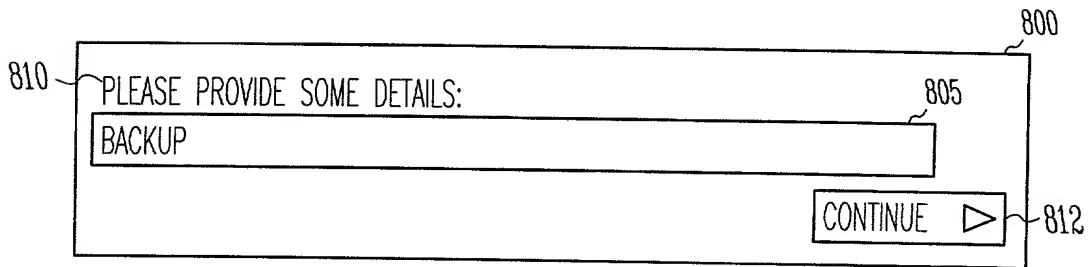

*Fig. 9B*

20090424

9/20

800

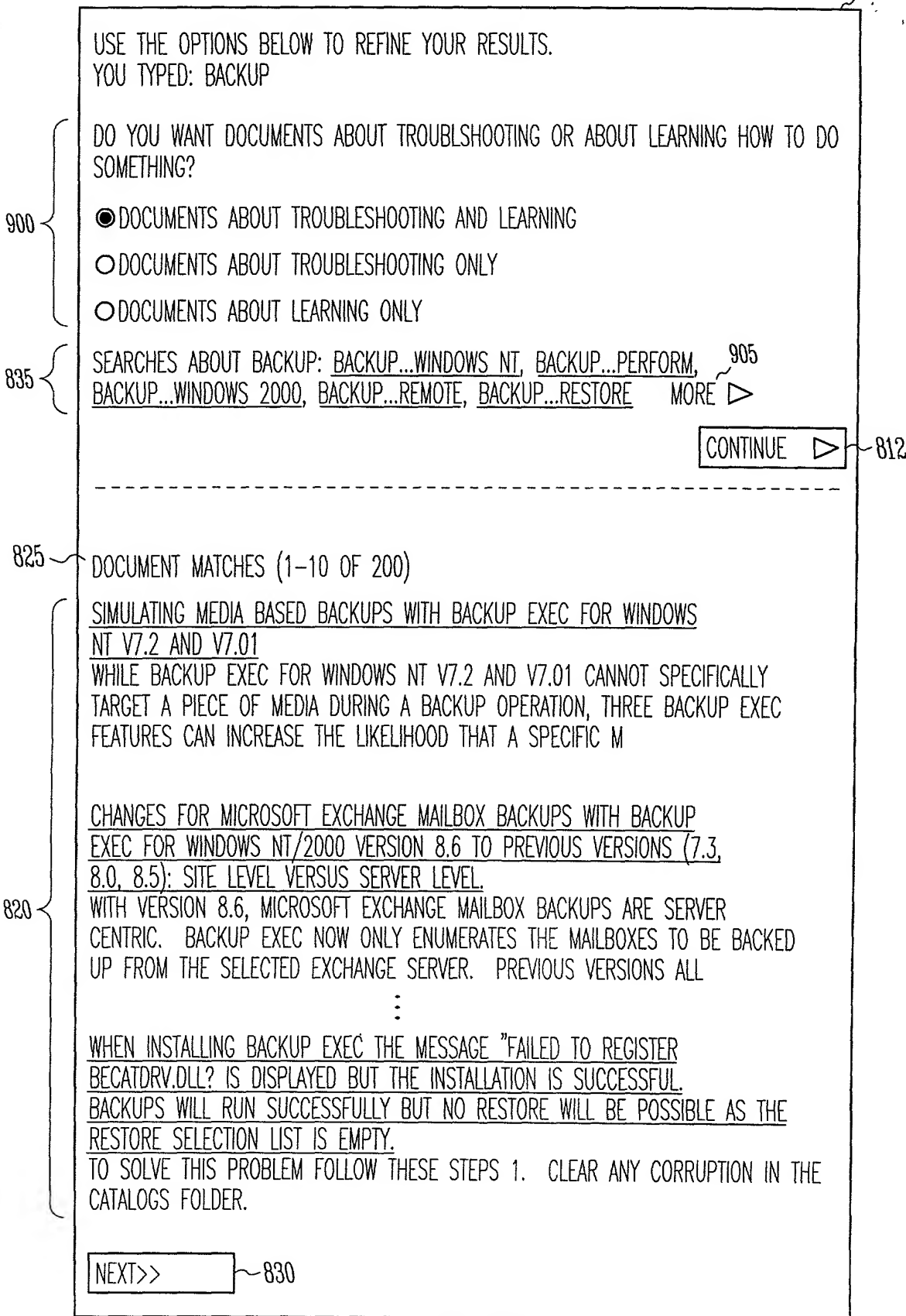

Fig. 9C

USE THE OPTIONS BELOW TO REFINE YOUR RESULTS.  
YOU TYPED: BACKUP

DO YOU WANT DOCUMENTS ABOUT TROUBLESHOOTING OR ABOUT LEARNING HOW TO DO SOMETHING?

900

- DOCUMENTS ABOUT TROUBLESHOOTING AND LEARNING
- DOCUMENTS ABOUT TROUBLESHOOTING ONLY
- DOCUMENTS ABOUT LEARNING ONLY

835

SEARCHES ABOUT BACKUP: BACKUP...WINDOWS NT, BACKUP...PERFORM,  
BACKUP...WINDOWS 2000, BACKUP...REMOTE, BACKUP...RESTORE ◀ HIDE CHOICES  
BACKUP...FILE, BACKUP...NETWARE, BACKUP...MICROSOFT EXCHANGE,  
BACKUP...SERVER, BACKUP...SYSTEM, BACKUP...REPORT, CRASH...BACKUP,  
BACKUP...EXCHANGE, BACKUP...DATABASE, BACKUP...MICROSOFT,  
BACKUP...COMPUTER, BACKUP...OPEN FILE OPTION, BACKUP...ORACLE,  
BACKUP...BACKUP OPERATION, BACKUP...LOG FILE

CONTINUE ▶

812

825

DOCUMENT MATCHES (1-10 OF 200)

SIMULATING MEDIA BASED BACKUPS WITH BACKUP EXEC FOR WINDOWS  
NT V7.2 AND 7.01

WHILE BACKUP EXEC FOR WINDOWS NT V7.2 AND V7.01 CANNOT SPECIFICALLY  
TARGET A PIECE OF MEDIA DURING A BACKUP OPERATION, THREE BACKUP EXEC  
FEATURES CAN INCREASE THE LIKELIHOOD THAT A SPECIFIC M

820

CHANGES FOR MICROSOFT EXCHANGE MAILBOX BACKUPS WITH BACKUP  
EXEC FOR WINDOWS NT/2000 VERSION 8.6 TO PREVIOUS VERSIONS (7.3,  
WITH VERSION 8.6, MICROSOFT EXCHANGE MAILBOX BACKUPS ARE SERVER

8.0, 8.5): SITE LEVEL VERSUS SERVER LEVEL.

CENTRIC. BACKUP EXEC NOW ONLY ENUMERATES THE MAILBOXES TO BE BACKED  
UP FROM THE SELECTED EXCHANGE SERVER. PREVIOUS VERSIONS ALL

⋮

WHEN INSTALLING BACKUP EXEC THE MESSAGE "FAILED TO REGISTER  
BECATDRV.DLL? IS DISPLAYED BUT THE INSTALLATION IS SUCCESSFUL.  
BACKUPS WILL RUN SUCCESSFULLY BUT NO RESTORE WILL BE POSSIBLE AS THE  
RESTORE SELECTION LIST IS EMPTY.

TO SOLVE THIS PROBLEM FOLLOW THESE STEPS 1. CLEAR ANY CORRUPTION IN THE  
CATALOGS FOLDER.

NEXT>>

830



11/20

800

USE THE OPTIONS BELOW TO REFINE YOUR RESULTS.

905 YOU TYPED: BACKUP

910 YOU ADDED: ALL DOCUMENTS, BACKUP+REMOTE

ADD TO SEARCH:

835 { ACTIVITY: OPERATE, CONFIGURE, INSTALL, SELECT, RESTORE MORE ▷  
SYMPTOM: NOT DISPLAYING, NOT STARTING, ERROR DISPLAYED, NOT RUNNING, CRASH  
MORE ▷  
TOPIC: REMOTE, WINDOWS NT, WINDOWS 2000, SERVER, ADMINISTRATION MORE ▷

INCLUDE ONLY ARTICLES THAT CONTAIN:

SEARCH: ALL WORDS ANY WORDS 915

825 -----  
DOCUMENT MATCHES (1-10 OF 98)

DURING THE BACKUP OF REMOTE COMPUTERS BACKUPS WILL FAIL WITH JOB LOG REPORTING THE ERROR ?THE CONNECTION TO THE DATA TO BACK UP HAS BEEN LOST. BACKUP SET CANCELLED.?  
THE MESSAGE RETURNED IS AS PER FIGURE 1. FIGURE 1 THERE ARE TWO POSSIBLE REASONS THIS ERROR MESSAGE IS REPORTED: 1. NETWORKING ISSUES CAUSING A BREAK IN COMMUNICATION

820 { CAN BACKUP EXEC FOR NT/2000 VERSION 8.0 PERFORM SIMULTANEOUS BACKUPS OF THE SAME REMOTE RESOURCE AND HAVE ALL SERVERS BENEFIT FROM THE USE OF THE AGENT ACCELERATOR?  
FOR ALL VERSIONS OF BACKUP EXEC FOR WINDOWS NT 7.X, THE FIRST BACKUP EXEC SERVER TO ACCESS THE REMOTE SERVER WOULD BENEFIT FROM THE BACKUP EXEC NT AGENT ACCELERATOR (NTAA). ANY ADDITIONAL BAC

⋮  
AN ERROR MESSAGE, ?UNABLE TO ATTACH TO \\SERVERNAME\SYSTEM? STATE. THE DEVICE CANNOT BE FOUND?. DURING THE BACKUP OF A REMOTE WINDOWS 2000 SERVER SYSTEM STATE.

AN ADMINISTRATOR MAY CONFIGURE A WINDOWS 2000-BASED COMPUTER TO PREVENT ANONYMOUS LOG ON ACCESS TO ALL RESOURCES SUCH AS BACKING UP A REMOTE SERVER, WITH THE EXCEPTION OF RESOURCES THE ANONYM

830

Fig. 9E

12/20

FIG. 9F

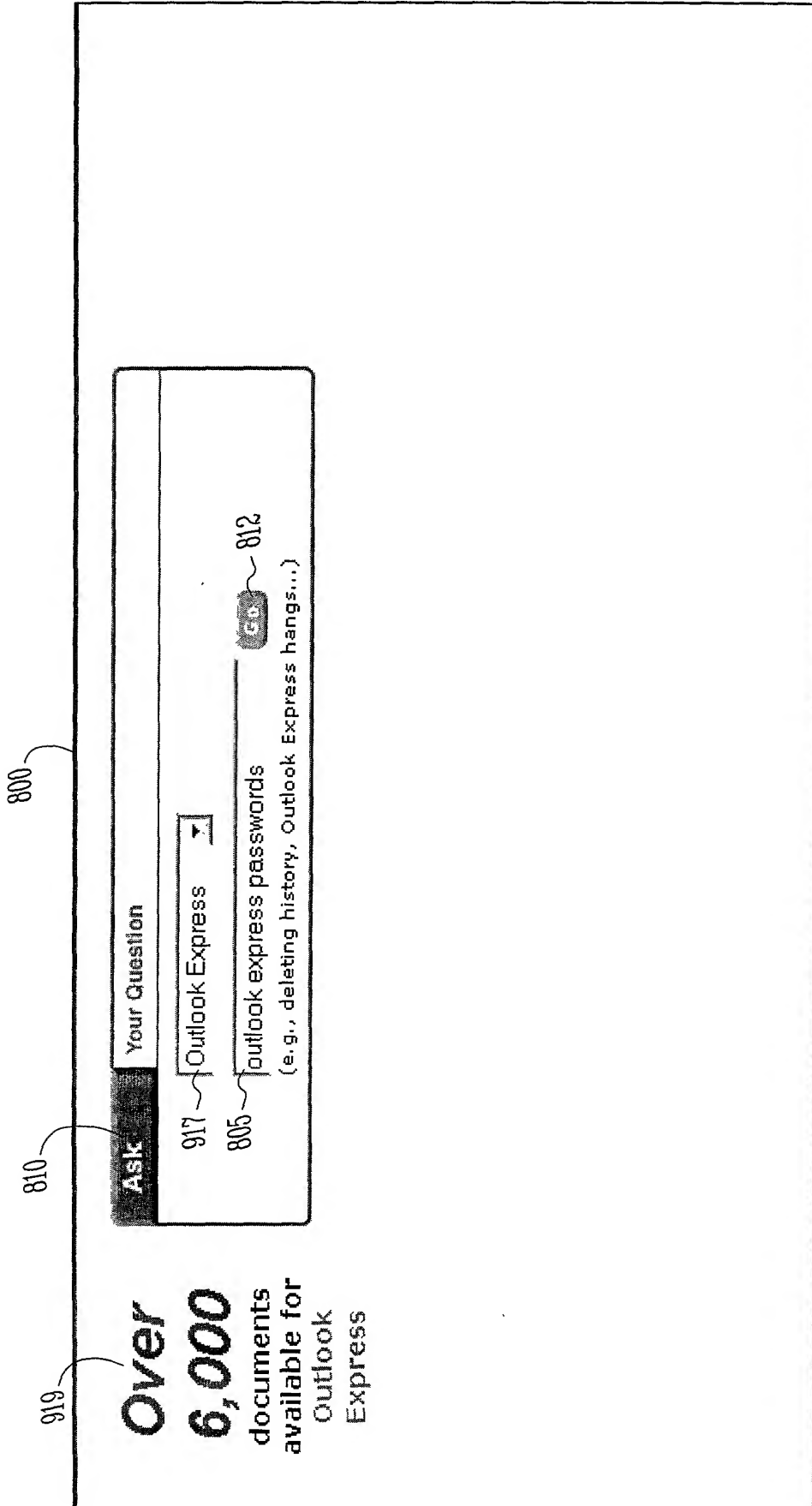



Fig. 9F

2002443 "Outlook Express"

800

805

outlook express passwords  812

---

**Ask** **Clarify** Your Question

Select one of these topics that appears near **passwords**:

- saving (2) ~ 925
- cannot connect (1) ~ 925

Select one of these topics that appears near **outlook**:

- error message (2) ~ 925
- logging on locally (2) ~ 925
- sending (2) ~ 925
- cannot send (1) ~ 925
- retrieving (1) ~ 925

If none of these are relevant, try filtering your results. 927

---

Current Results: 1-10 of **15** shown for Outlook Express page 1 | 2 Next

1. Q258194 - OLEXP: Protecting Passwords for Outlook Express Identity 921  
*Except from this page: If you have password-protected your identity in Outlook Express and you log on to Microsoft Windows 95 or Microsoft Windows 98 as a different user, the identity's password is not verified. This issue is only related to the single-user...*
2. Q216382 - OLEXP: Outlook Express Does Not Save the Mail Server Logon Password  
*Except from this page: When you set up your Mail account in Outlook Express, you cannot save your mail server logon password for incoming mail....*
3. Q221157 - OLEXP: Forgotten Identity Passwords Are Not Recoverable  
*Except from this page: If you forget the password for your identity in Outlook Express, the password is not recoverable....*

923

919

15

results below



Fig. 96

20220404 "SEARCH" 4/13/04

805 outlook express passwords

Ask

Filter

Your Results

Show only documents that contain:  Filter

Or select one of these common topics: 929

**Actions:**

- logging on locally (6) ~ 925
- connecting (5) ~ 925
- sending (4) ~ 925
- saving (4) ~ 925
- deleting (3) ~ 925

More

**Problems:**

- error message (7) ~ 925
- server error (3) ~ 925
- access denied (2) ~ 925
- cannot connect (2) ~ 925
- cannot send (2) ~ 925

More

919

15 results below

\*\*\*\*\*

Current Results: 1-10 of 15 shown for Outlook Express

- Q258194 - OLEXP: Protecting Passwords for Outlook Express Identity ~ 921  
Except from this page: If you have password-protected your identity in Outlook Express and you log on to Microsoft Windows 98 as a different user, the identity's password is not verified. This issue is only related to Outlook Express.
- Q216382 - OLEXP: Outlook Express Does Not Save the Mail Server Logon Password ~ 921

Fig. 9H

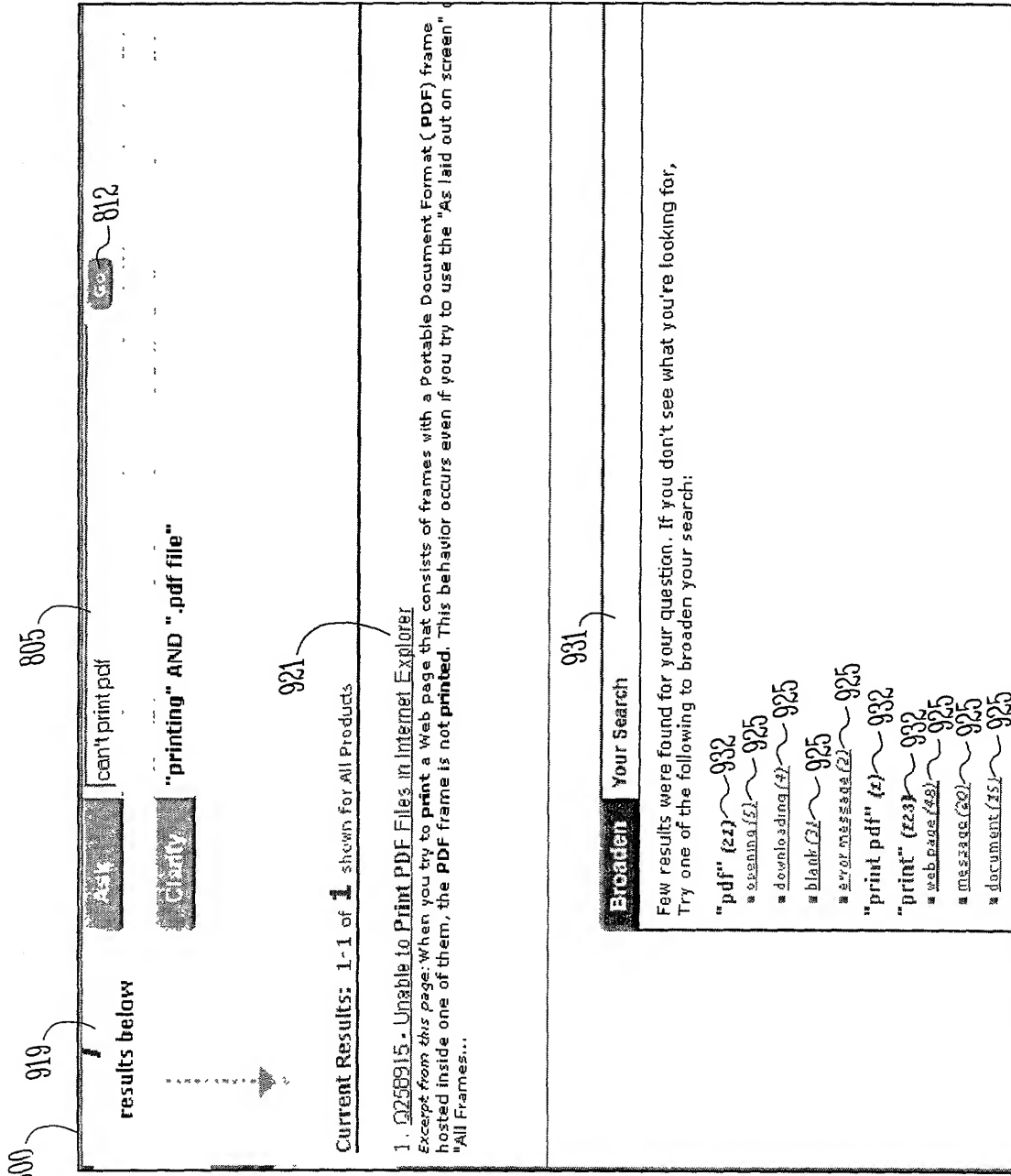

Fig. 91

200240 "SEARCH"

800

805 983

Ask print 812

Clarify "printing" AND "message"

Filter Your Results

934 Show only documents that contain: Filter

919 20 results below

Or select one of these common topics: 929

Problems:

- error message (5) 925
- cannot print (3) 925
- unspecified error (2) 925
- blank (1) 925
- corrupted (1) 925

Topics:

- document (6) 925
- file (6) 925
- printer (6) 925
- web page (6) 925
- web page (6) 925

page 1 | 2

Current Results: 1-10 of 20 shown for All Products

- 0226540 - OLEXP: Unable to Print When the Preview Pane Is Not Enabled 921  
Except from this page: When you try to print a message, your message may not print, and you may not receive an error message
- 0191034 - Err Msg: Unable to Print Document, Either Document's... 921  
Except from this page: When you try to print a web page and all of its linked documents by clicking Print All Linked Documents, you may receive any of the following error messages: Unable to print document, either document's application is not installed correct
- 0226223 - OLEXP: Unable to Print in Outlook Express 4.x 921

Fig. 9J

202240 "SEARCH"

800

805

933

Ask

how to remove defunct ISP from outlook express

Go

Clarify

"deleting" AND "Outlook"

Alternatives to Your Search

919

Sorry,

0

results found

936

Sorry, no results were found with your question, try one of the following to broaden your search:

- "ISP" (13) ~ 932
  - connecting (4) ~ 925
- "outlook" (200) ~ 932
  - starting (42) ~ 925
  - installing (30) ~ 925
  - configuring (20) ~ 925
  - importing (15) ~ 925
- "remove ISP" (2) ~ 932
- "remove outlook" (14) ~ 932
- "remove" (29) ~ 932
  - Outlook (10) ~ 925
  - message (6) ~ 925
  - file (4) ~ 925

Fig. 9K

1110	1115	1120	1125
TERMS	A O P S	A? O? P? S?	D
ITEM BEING	<input type="checkbox"/> <input type="checkbox"/> <input type="checkbox"/> <input type="checkbox"/>	<input type="checkbox"/> <input type="checkbox"/> <input type="checkbox"/> <input type="checkbox"/>	<input type="checkbox"/>
DELETE FONT	<input type="checkbox"/> <input type="checkbox"/> <input type="checkbox"/> <input type="checkbox"/>	<input type="checkbox"/> <input type="checkbox"/> <input type="checkbox"/> <input type="checkbox"/>	<input type="checkbox"/>
⋮	⋮	⋮	⋮
LOCKING MECHANISM	<input type="checkbox"/> <input type="checkbox"/> <input type="checkbox"/> <input type="checkbox"/>	<input type="checkbox"/> <input type="checkbox"/> <input type="checkbox"/> <input type="checkbox"/>	<input type="checkbox"/>
⋮	⋮	⋮	⋮
CAN'T FIND FOLDER	<input type="checkbox"/> <input type="checkbox"/> <input type="checkbox"/> <input type="checkbox"/>	<input type="checkbox"/> <input type="checkbox"/> <input type="checkbox"/> <input type="checkbox"/>	<input type="checkbox"/>

1100

Fig. 11

1210	1215	1220
TERMS FILTERED BY GROUP: ACTIVITY	CONCEPTS HAVING AS EVIDENCE TERMS SIMILAR TO THE SELECTED TERM(S)	DOCUMENTS HAVING THE SELECTED TERM(S)
⋮	BROWSE	D28
⋮	OFFLINE BROWSE	D305
⋮	⋮	D763
BROWSE	⋮	⋮
⋮	⋮	⋮

1200

1205

Fig. 12



1310	1315	1320	1325	1330
TERMS/PAIRS/GROUPS	DOCS	OCCUR	CONCEPTS HAVING AS EVIDENCE TERMS SIMILAR TO THE SELECTED TERMS/PAIRS/GROUPS	DOCUMENTS HAVING THE SELECTED TERMS/PAIRS/GROUPS
:	:	:	BROWSE	D28
BROWSE_ADDRESS_BOOK	1	3	OFFLINE BROWSE	D305
:	:	:	:	D763
:	:	:	:	:

Fig. 13